



13046 Race Track Rd. #187  
Tampa, FL 33626  
(813) 463-2420  
www.eag-led.com

## HIGH BAY LIGHT



### Advantages

- UL cUL DLC certificate
- High CRI
- IP65 driver, Input voltage 100-277Vac
- No UV or IR in the beam
- Easy to install and operate
- Light is soft and uniform, Safe to eyes
- Energy saving, Long lifespan
- Instant start, NO flickering, NO humming
- Green and eco-friendly without mercury.
- Fully dimmable, motion sensor capabilities

### Applications

- Warehouse, factory, workshop
- Gas stations, toll station
- Gymnasium



13046 Race Track Rd. #187  
 Tampa, FL 33626  
 (813) 463-2420  
 www.eag-led.com

# HIGH BAY LIGHT

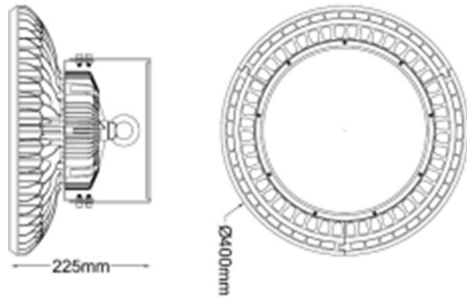

Option 1

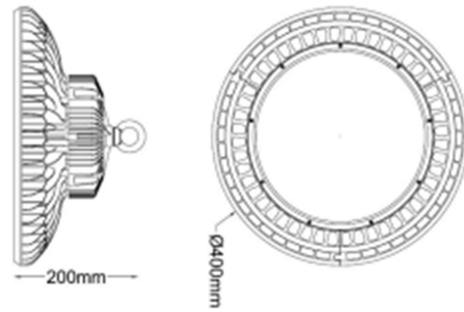

Option 2

## Technical Specifications

Color Temperature	4000 – 5700K	Operating Hours	50,000
CRI	>80	Operating Temperature	-20°C TO 40°C
Lumen	39000LM	Operating Humidity	20% - 90% RH
Input Power	300W	Storage Temperature	-30°C TO 80°C
Viewing Angle	120 Degree	Storage Humidity	10% - 95% RH
Input Voltage	50-60 HZ	Application	Outdoor/Indoor
Waterproof Rating	IP65	Certification	UL cUL DLC
PFC	>.9	Housing	Aluminum

Product Specifications		Materials	
Product Name	LED High Bay Light	LED Brand	Phillips Lumileds
Part Number	EAG-HB2-300W	LED Type	Luxeon 3030 2D (1.5W)
Dimension	1: 400*200mm 2: 400*225mm	Driver	HBG-100-60B (Mean Well)