

LED SHOEBOX LIGHT / 200W

TECHNICAL DATA SHEET

Introduction

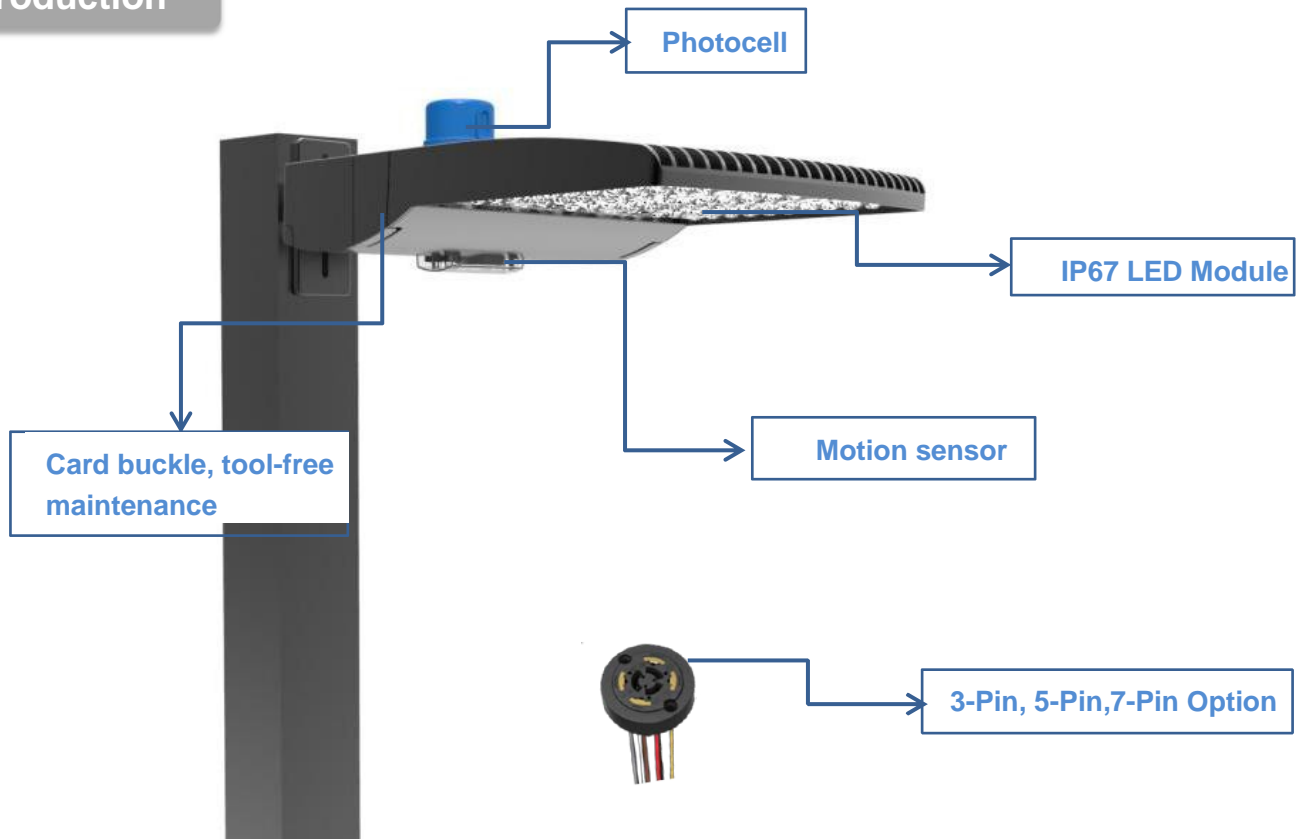

Different Installations

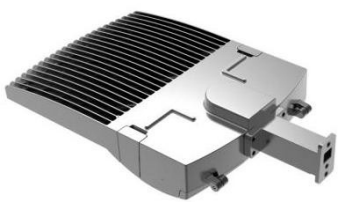

Arm(Square Pole)-M



Arm(Round Pole)-M



Arm(Square Pole)-L

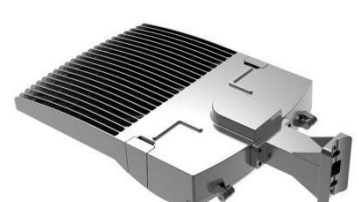

Arm(Round Pole)-L



Arm-one-key operate

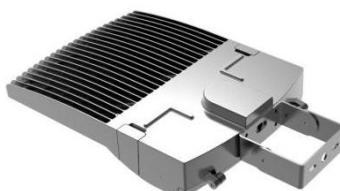

Trunnion



Slip fitter

Note: M-Medium, L-Large

LED SHOEBOX LIGHT 200W



TECHNICAL DATA SHEET

FEATURES



- High lumen efficacy, up to 140lm/W
- Modularized design, easy for local assembly
- Slim appearance, low wind resistance
- One person installation
- Good ID design to achieve self-clean
- Cover for debris buildup option

SPECIFICATIONS

Model	EAG-SBP200
Power Consumption	200W
Input Voltage	120-277VAC / 277-480VAC
Power Factor	>0.90
Lumen Efficiency	150lm/W
Lumen	30000lm
LED Brand	Lumileds 3030/Osram 3030
CCT	3000K/4000K/5000K
CRI	75
Optics	Type2/Type3
Finish	Dark Bronze/White/Grey
Dimmable	Dim
Lifespan	50,000hrs
Operating Temperature	-20~40°C
Driver Brand	Inventronics



DIMENSION

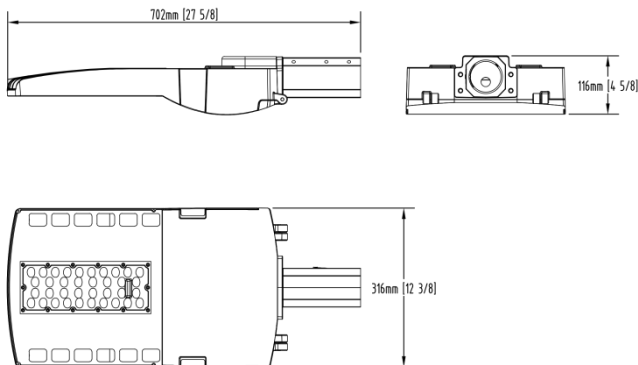

DISTRIBUTION CURVE

